

SMD Power Inductor CDRH15D78/A

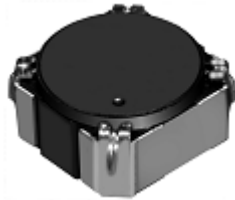

Description

- Ferrite drum core construction.
- Magnetically shielded.
- L × W × H: 15.5 × 15.5 × 8.0 mm Max.
- Product weight :4.0g(Ref.)
- Moisture Sensitivity Level: 1
- RoHS compliance.
- Qualification to AEC-Q200.

Environmental Data

- Operating temperature range: -40°C~+125°C
- Storage temperature range: -40°C~+85°C
- Solder reflow temperature: 260 °C peak.

Packaging

- Carrier tape and reel packaging
- 14.5" diameter reel
- 500pcs per reel

Applications

- Automotive and other high temperature, high reliability application.

Dimension - [mm]

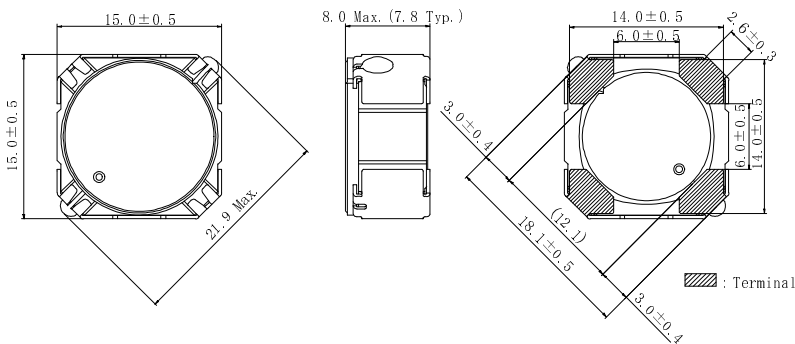

Land pattern and Schematics - [mm]

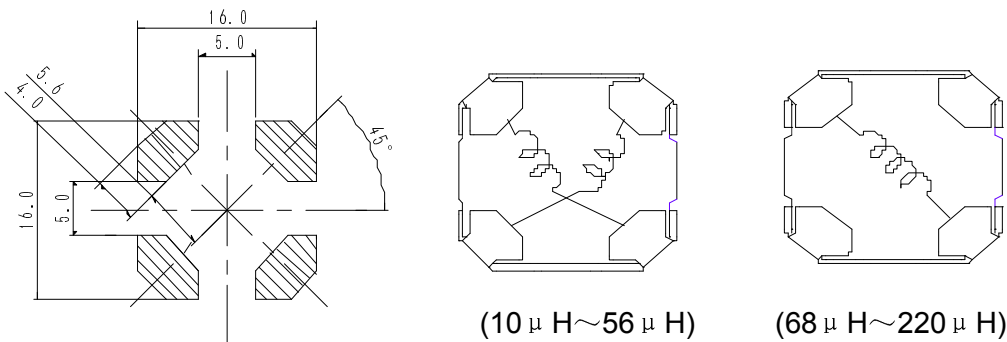

SMD Power Inductor

CDRH15D78/A



Electrical Characteristics

Part name	Stamp	Inductance (μ H) [within] ※1	D.C.R. (m Ω) [Max.] (Typ.) (at 20°C)	Rated current (at 125°C) (A) ※2
CDRH15D78/ANP-10 \emptyset MC	100M	10 \pm 20%	16.3(13)	5.38
CDRH15D78/ANP-12 \emptyset MC	120M	12 \pm 20%	18.8(15)	4.42
CDRH15D78/ANP-15 \emptyset MC	150M	15 \pm 20%	20.0(16)	4.14
CDRH15D78/ANP-18 \emptyset MC	180M	18 \pm 20%	25.0(20)	3.90
CDRH15D78/ANP-22 \emptyset MC	220M	22 \pm 20%	27.5(22)	3.55
CDRH15D78/ANP-27 \emptyset MC	270M	27 \pm 20%	36.3(29)	3.20
CDRH15D78/ANP-33 \emptyset MC	330M	33 \pm 20%	37.5(30)	2.75
CDRH15D78/ANP-39 \emptyset MC	390M	39 \pm 20%	41.3(33)	2.68
CDRH15D78/ANP-47 \emptyset MC	470M	47 \pm 20%	43.8(35)	2.52
CDRH15D78/ANP-56 \emptyset MC	560M	56 \pm 20%	57.5(46)	2.26
CDRH15D78/ANP-68 \emptyset MC	680M	68 \pm 20%	67.5(54)	2.05
CDRH15D78/ANP-82 \emptyset MC	820M	82 \pm 20%	75.0(60)	1.87
CDRH15D78/ANP-101MC	101M	100 \pm 20%	100.0(80)	1.70
CDRH15D78/ANP-121MC	121M	120 \pm 20%	130.0(104)	1.55
CDRH15D78/ANP-151MC	151M	150 \pm 20%	152.5(122)	1.38
CDRH15D78/ANP-181MC	181M	180 \pm 20%	167.5(134)	1.28
CDRH15D78/ANP-221MC	221M	220 \pm 20%	216.3(173)	1.17

※1. Measuring condition: at 100 kHz.

※2. Rated current: The DC current at which the inductance decreases to 65% of its nominal value or when $\Delta t=30^{\circ}\text{C}$, whichever is lower .

SMD Power Inductor CDRH15D78/A



Saturation Current & Temperature Rise Graph

— L (20°C) — L (125°C) — ΔT

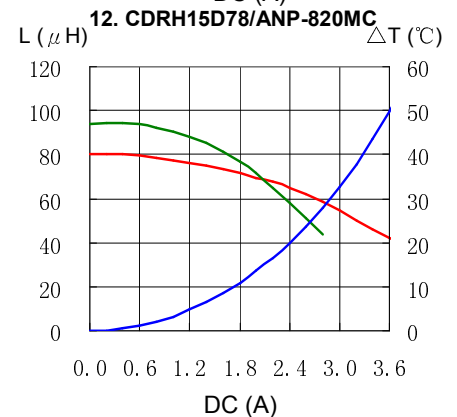
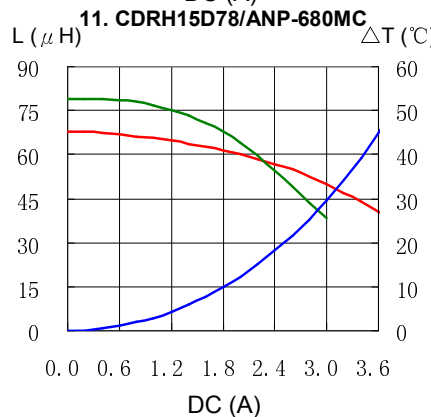
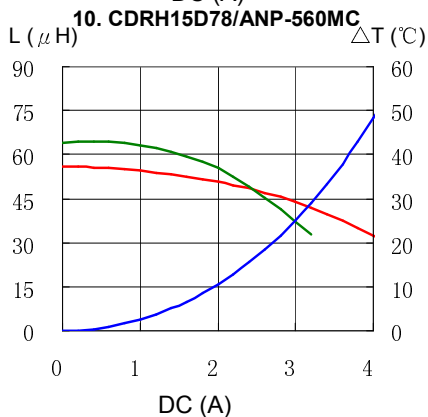
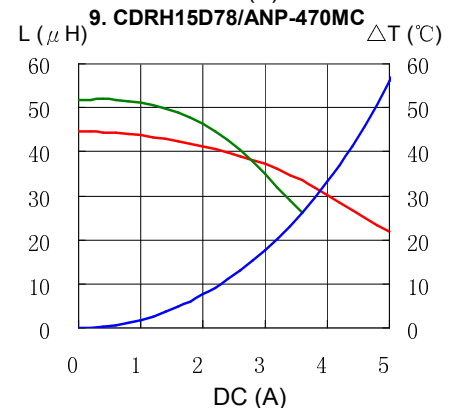
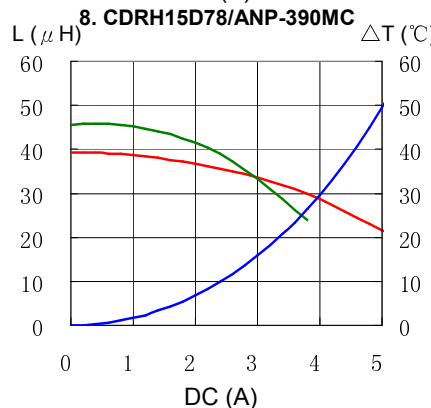
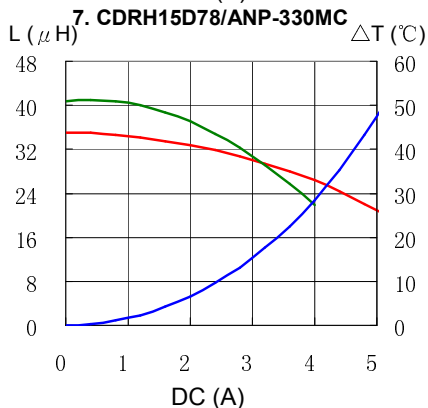
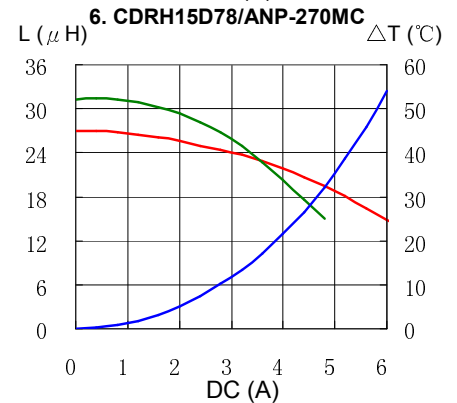
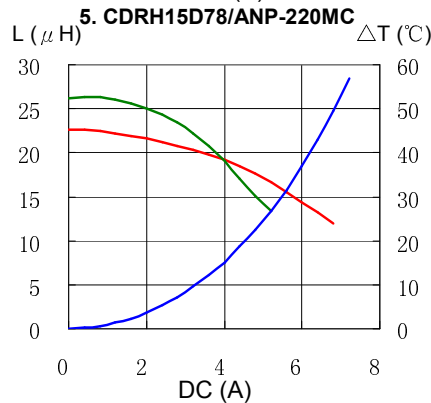
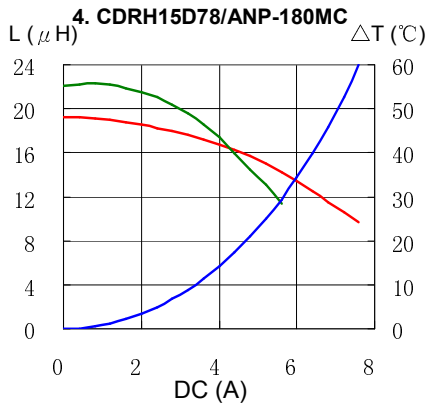
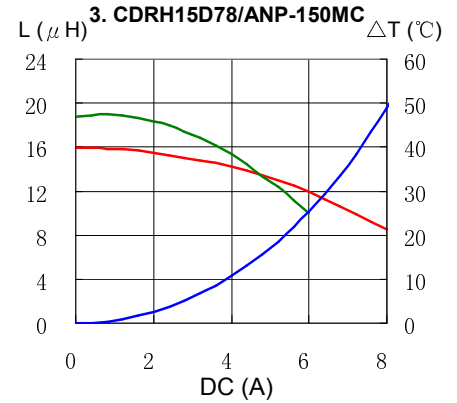
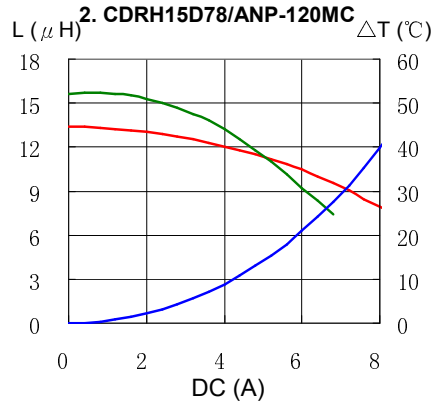
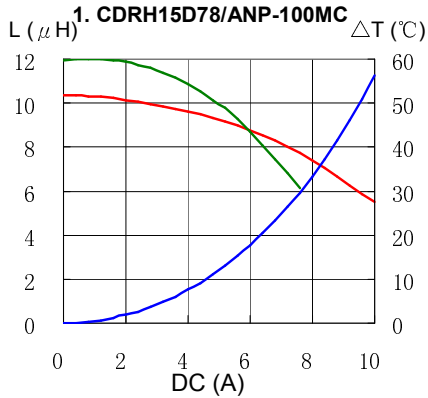

SMD Power Inductor CDRH15D78/A



Saturation Current & Temperature Rise Graph

— L (20°C) — L (125°C) — ΔT

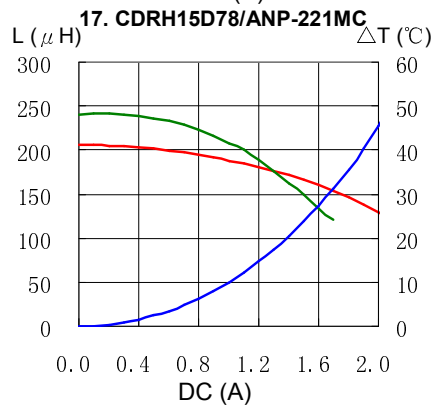
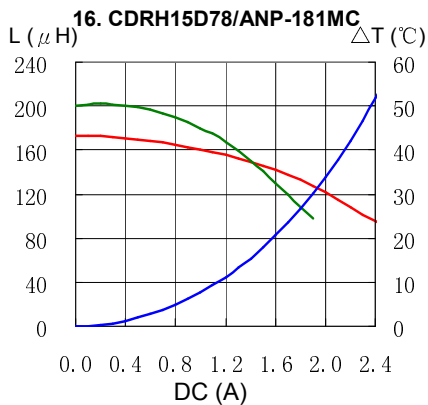
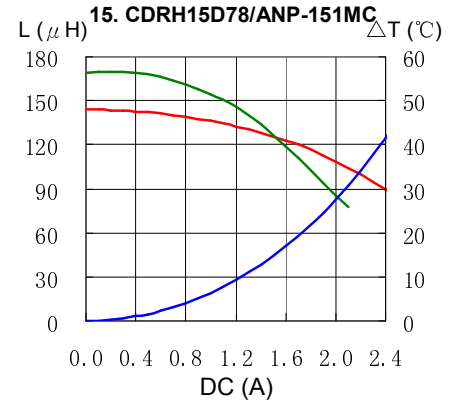
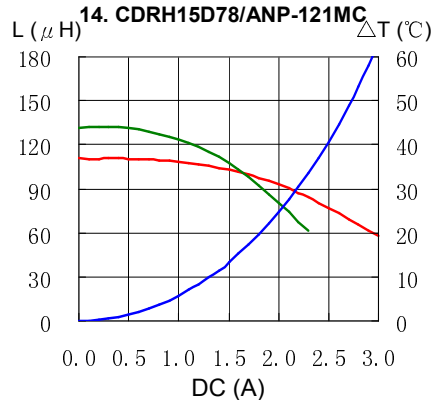
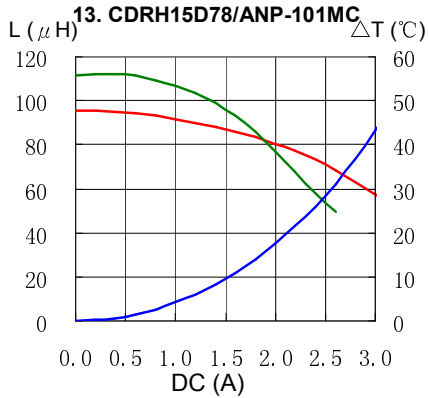

Solder Reflow Condition

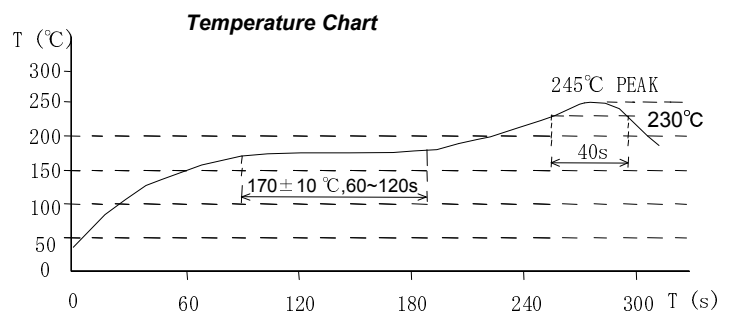
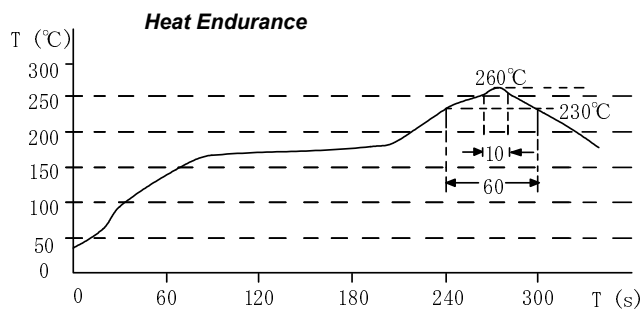

Please refer to the sales offices on our website - <http://www.sumida.com>

Hong Kong
Tel.+852-2880-6688
FAX.+852-2565-9600
sales@hk.sumida.com

Tokyo
Tel.+81-3-5202-7112
FAX.+81-3-5202-7105
sales@jp.sumida.com

Chicago
Tel.+1-847-545-6700
FAX. +1-847-545-6720
sales@us.sumida.com

Shanghai
Tel.+86-021-5836-3299
FAX.+86-021-5836-3266
shanghai.sales@cn.sumida.com

Seoul
Tel.+82-2-6237-0777
FAX.+82-2-6237-0778
sales@kr.sumida.com

Oberzell
Tel.+49-8591-937-0
FAX. +49-8591-937-103
contact@sumida-eu.com

Shenzhen
Tel.+86-755-8291-0228
FAX.+86-755-8291-0338
shenzhen.sales@cn.sumida.com

Singapore
Tel.+65-6296-3388
FAX.+65-6296-3390
sales@sg.sumida.com

Neumarkt
Tel.+49-9181-4509-110
FAX. +49-9181-4509-310
infocomp@eu.sumida.com

Taipei
Tel.+886-2-8751-2737
FAX.+886-2-8751-2738
sales@tw.sumida.com

San Jose
Tel.+1-408-3219660
FAX.+1-408-321-9308
sales@us.sumida.com